

COLOUR TELEVISION

SANYO

CHASSIS SERIES **EB6D**

MODEL NUMBER **CE28CN6-C**

SERVICE REF.NO. **CE28CN6-C-00**

The service Precaution:
 The area enclosed by this line () is directly connected with AC mains voltage. When servicing the area, connect an isolating transformer between TV receiver and AC line to eliminate hazard of electric shock.

Product safety notice:
 Product safety should be considered when a component replacement is made in any area of a receiver. Components indicated by a mark  in this circuit diagram show components whose values have special significance to product safety. It is particularly recommended that only parts specified on the part service manual be used for components replacement pointed out by the mark.

- Circuit diagram notes :**
- All resistance values are in ohms, K=1,000, M=1,000,000.
 - All resistance rated wattages are 1/6W unless otherwise noted.
 - Excepting electrolytic capacitors, all capacitance values of less than 1 are expressed in μF and more than 1 are pF.
 - All capacitance rated voltages are 50V unless otherwise noted.
 - All inductance values are in μH .
 - Voltage readings taken a digital voltmeter are from point indicated chassis ground. Voltage readings taken by using a colour bar signal are with all controls at normal position. Some voltages may vary with signal strength.
 - Waveforms were taken with colour bar and controls adjusted for normal picture. Waveforms were taken by using a wide band oscilloscope and a low capacity probe.

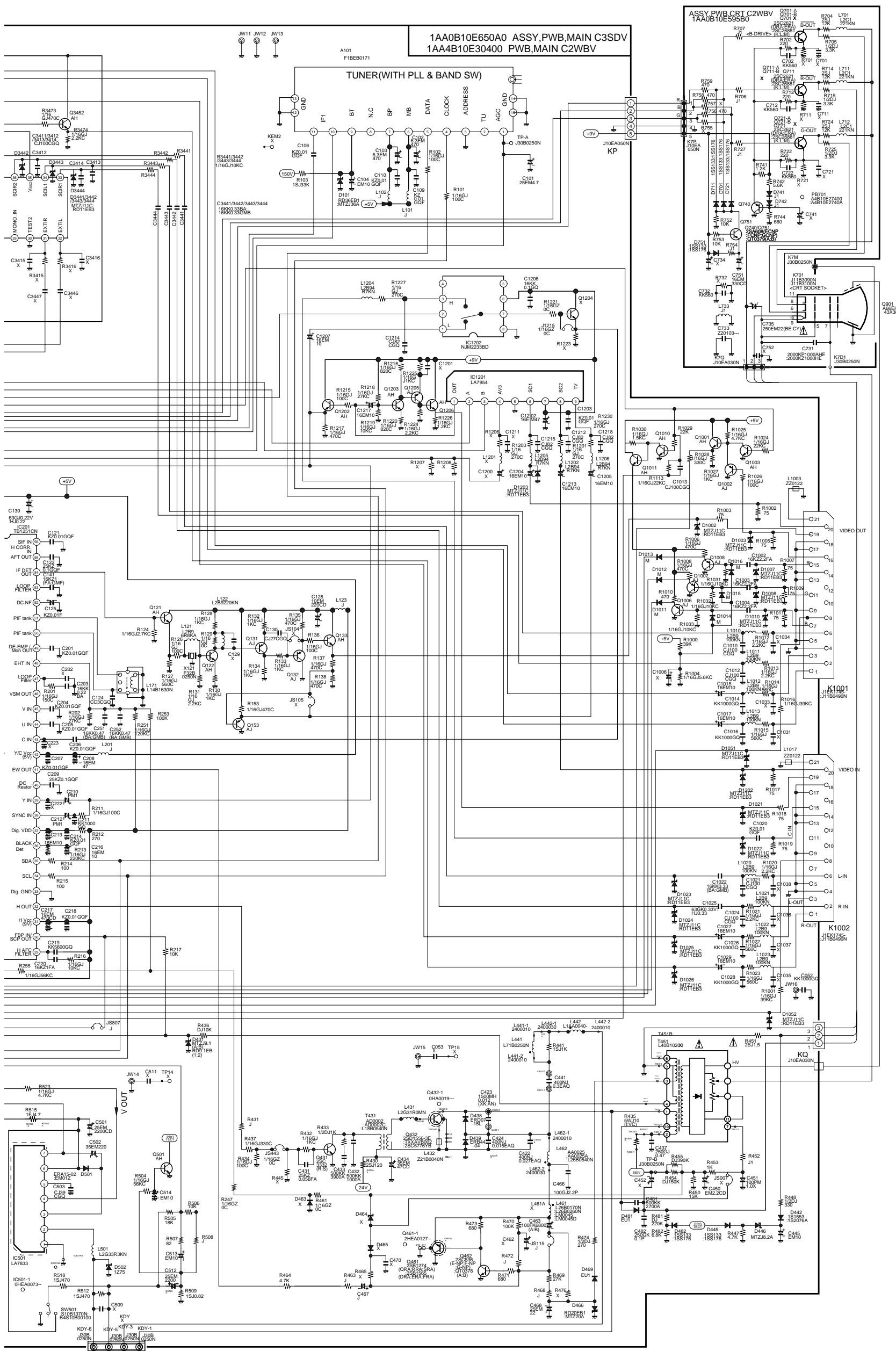

Expression of capacitance and resistance in circuit diagram.

8. This circuit diagram covers a basic or representative chassis only. There may be some components or partial circuit differences between the actual chassis and the circuit diagram.
9. ■ Diode 1S1555 may be replaced with 1S2473, 1S2076 or DS472 unless otherwise noted.
- Transistor 2SC536(Q,R,S), 2SC1740(Q,R,S), 2SC945A(Q,R,P) or 2SC1815(G,O,Y) unless otherwise noted.
- Transistor 2SA608(E,F) may be replaced with 2SA933(Q,R), 2SA564(QA,RA), or 2SA1015(O,Y) unless otherwise noted.

Capacitance (Example)

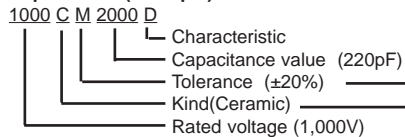

Resistance (Example)

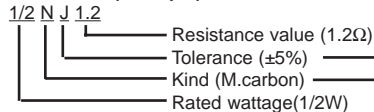

J = ± 5%
K = ± 10%
M = ± 20%

T, A, U, D : Electrolytic
C, K, B : Ceramic
F : Mylar film
M, N : Polypropylene
Z : Metallized paper

D : Carbon
N : Metallized carbon
S : Oxide metallized
W : Wire winding
C : Solid

Terminal guide

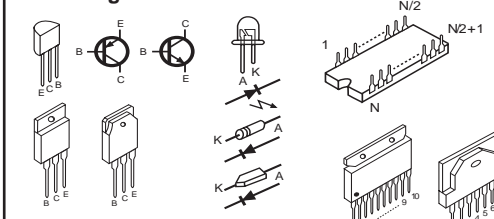

Chip Components

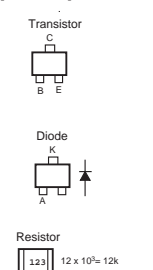

C : Collector
B : Base
E : Emitter

A : Anode
K : Cathode

MAIN BOARD

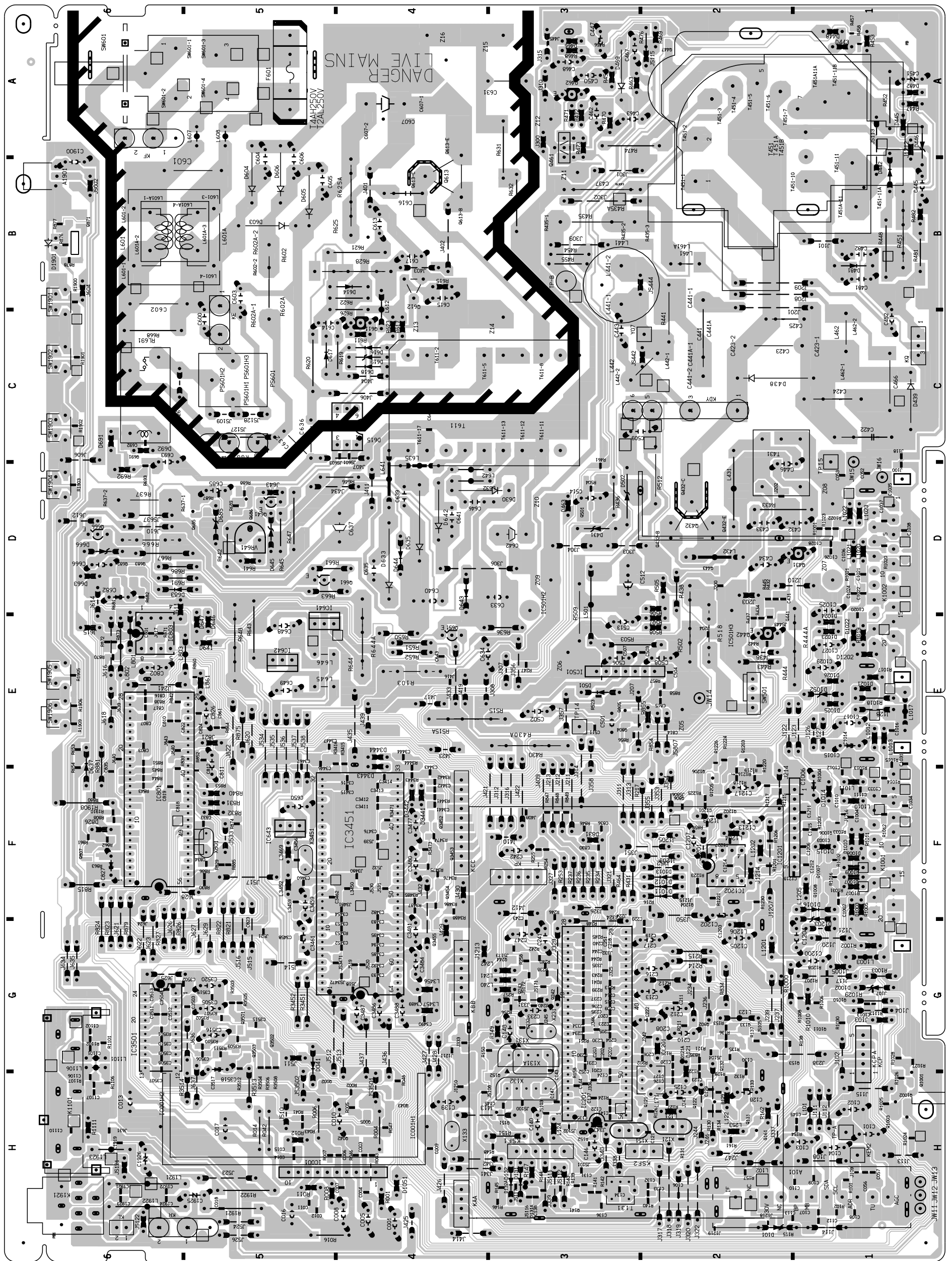

MAIN BOARD

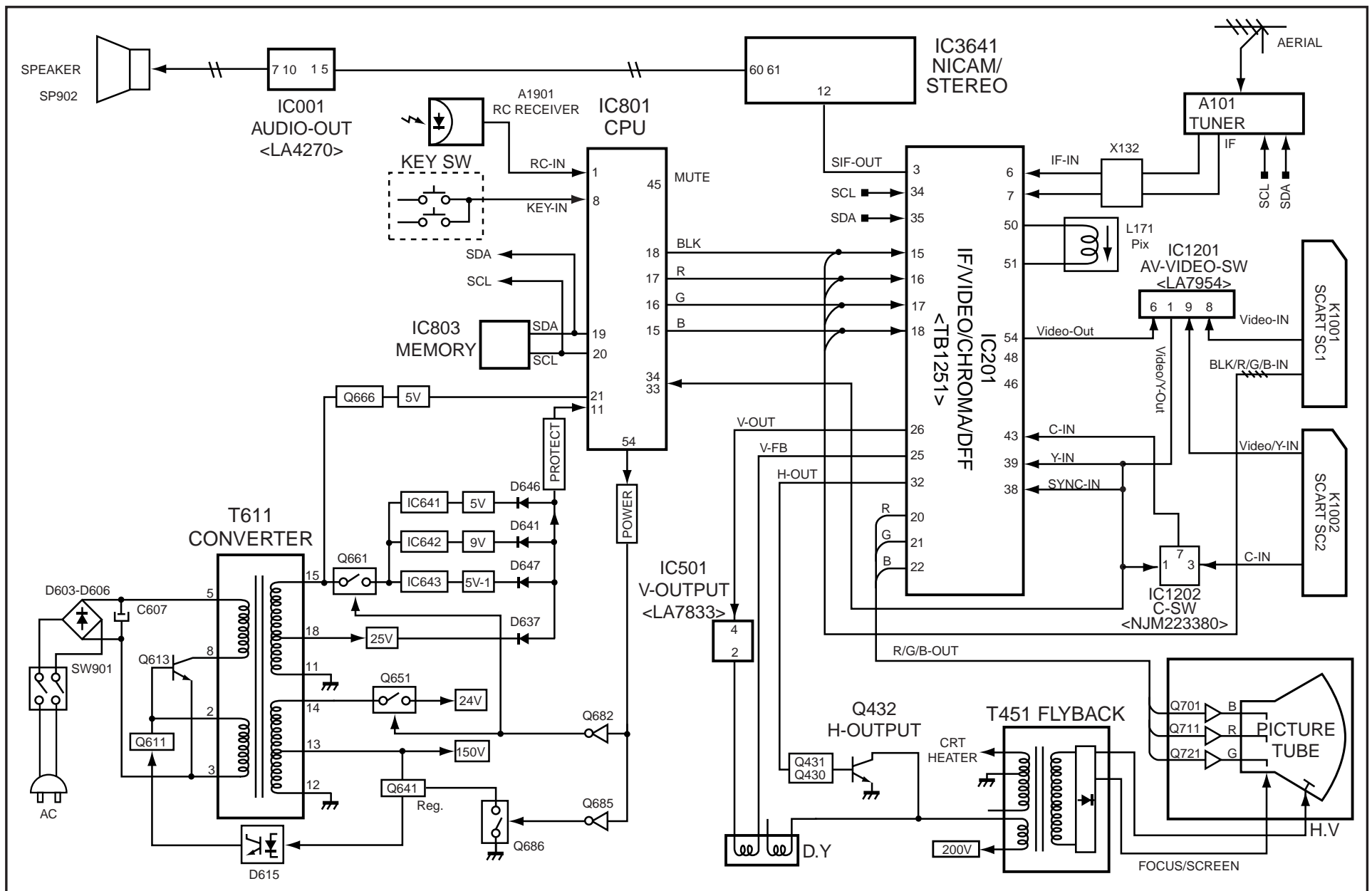
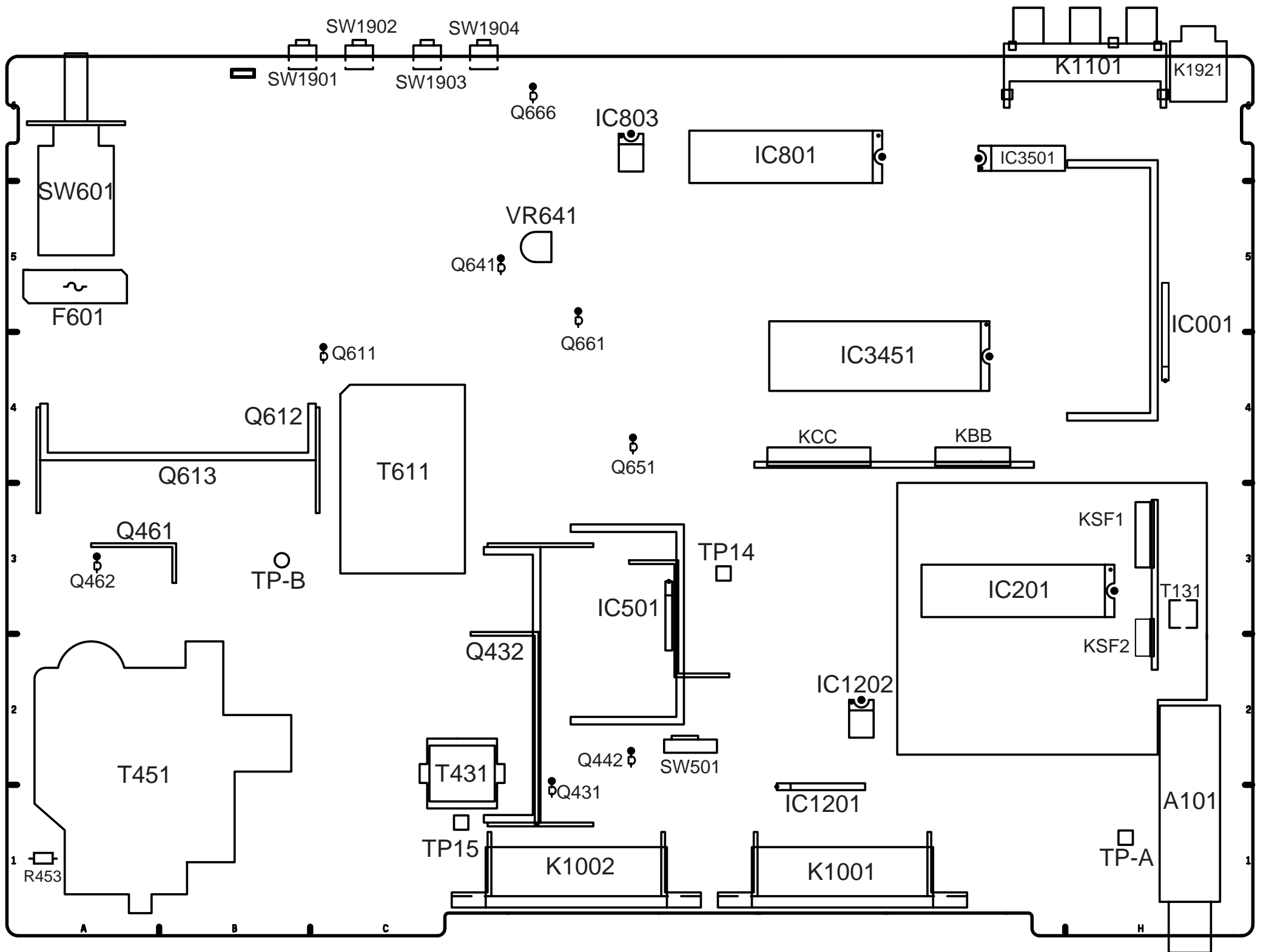

SERVICE ADJUSTMENTS

[After replacing the Memory IC (IC803)]

The memory IC, IC803, stores the feature setting data of TV set and service adjustments data for each circuit, therefore, when the memory IC is replaced, it should be performed by following "OPTION SETTING" and "SERVICE ADJUSTMENT".

To enter the Option Mode

+ Press and hold the **F/OK** button on the remote control and **P▼** button on the front panel of the TV. The option window will appear on the screen.

ON TIMER	ON
Wel. TEXT	ON
P&P	ON
SORT MODE	Tuning
Destination	BG/DK
3D Surround	OFF
2 step mute	ON
AV3 mode	OFF

To set the option mode

+ Highlight the desired option item by using the **P▲** or **P▼** button.
+ To switch the option mode, use the **◀** - (LEFT) or **▶** + (RIGHT) button.
+ The data which is set in the option mode is stored into the memory IC automatically.

Following table shows the available option items and default setting mode.

Option Mode	Mode	Description & Note
ON-TIMER	ON or OFF	On-timer available, default "ON"
Wel. Text	ON or OFF	Display message when first set up, default "ON"
P&P	ON or OFF	Plug & Play mode, default "ON"
SORT MODE	Tuning or Sorting	Tuning mode, default "Tuning"
Destination	BG/DK	Destination option ,BG, BG/DK, SECAM, I-UK, I-IRE, default "BG/DK"
3D Surround	ON or OFF	Wide Screen Signaling available, default "ON"
2 step mute	ON or OFF	Mute mode option, default "OFF"
AV3 mode	ON or OFF	Front AV mode option, default "ON"

Exit from the Option Mode

+ Press the **MENU** button.

SERVICE ADJUSTMENTS

[SERVICE ADJUSTMENT]

Note: Some items of the service adjustments for this chassis are controlled by the CPU, IC801, and the adjustments are carried out by using the RC handset.

IMPORTANT NOTICE

Do not attempt to adjust service adjustments not listed on the above otherwise it may cause loss of performance and product safety.

To enter the Service Mode

+ Press and hold the **"GREEN"** button and the **P▼** button on front control panel. The adjustment item will be displayed on the screen.



The available adjustment items are as follows;

Image : This can be adjusted for picture images/shapes.
Regular : This can be adjusted for the service adjustment.
other : This is for factory setting. Do not adjust.
TB1251 : This is for the factory setting. Do not adjust.

* Do not adjust items in the "other" and "TB1251" otherwise the TV set may not operate properly.

To select the mode and service item and change data value

+ Select the desired adjustment mode (**Image** or **Regular** mode) by using the **P▲** or **P▼** button and then press the **Volume + (RIGHT)** button.
+ To select the adjustment item, use the **P▲** or **P▼** button.
+ To change the service data, use the **◀** - (LEFT) or **▶** + (RIGHT) button.
+ The data which is set in the service mode is stored into the memory IC automatically.

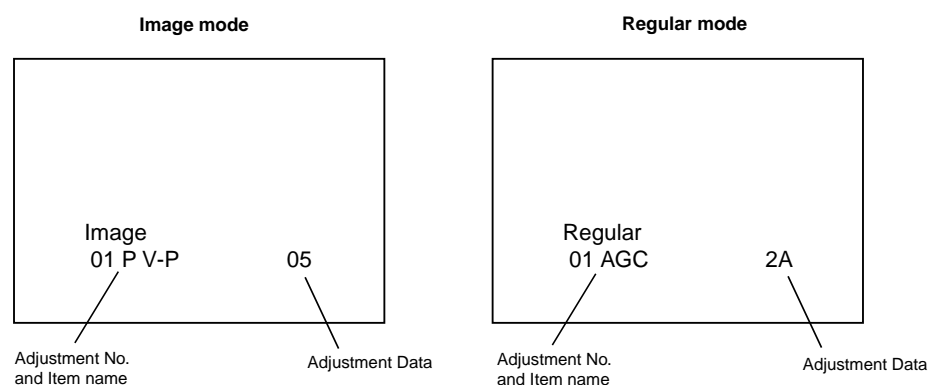

SERVICE ADJUSTMENTS

ADJUSTABLE SERVICE ADJUSTMENT

IMPORTANT NOTICE

Do not attempt to change the data value of service items not listed below table otherwise it may cause loss of performance and product safety. If you can not restore the data value of each service item, please initialize the memory IC following to the below description "INITIALIZATION OF MEMORY IC" and re-adjust all of service adjustments.

[Image]

Item No.	OSD	Description
01	P V-P	PAL Vertical Phase Adjustment
02	P H-P	PAL Horizontal Phase Adjustment
03	P V-L	P Vertical Linearity Adjustment
04	P VSC	Vertical Scroll Adjustment
05	P V-S	Vertical Size Adjustment

[Regular]

Item No.	OSD	Description
1	AGC	AGC Adjustment
2	--	Cut-off Adjustment
3	GRY	Grey Scale Adjustment [White Balance]
4	CTR	Contrast Adjustment (Factory use, use default setting data)
5	SCR	Screen adjustment (Factory use, use default setting data)
6	OSD	On-screen Display Positioning Adjustment

Exit from the Service Mode

+ Press the **MENU** button or turn off the TV set by using the Mains switch.

[INITIALIZATION OF MEMORY IC]

To initialize the memory IC (IC803), press and hold the **→←** button and then press the **P▼** button on the front control panel, and then turn the Mains switch Off and On. Now the initialization is completed.

When initialized the memory IC, all of the setting data (option setting data and service adjustment data) stored in the IC are reset to the default value. So it is necessary to set the option setting and readjust the service adjustments listed on the above.

SERVICE ADJUSTMENTS

[ADJUSTMENTS]

How to adjust the each service data, Please see "SERVICE ADJUSTMENT" for Entering the Service mode, Selecting service item and Adjusting the service data value.

IMPORTANT NOTICE

Do not attempt to adjust the following service adjustments except requiring the readjustments in servicing otherwise it may cause loss of performance and product safety.

+B ADJUSTMENT

- Receive white raster pattern.
- Set controls to normal.
- Connect digital voltmeter to test point TP-B and GND.
- Adjust voltage to 110 ±0.5V by using VR641 (21").
Adjust voltage to 150 ±0.5V by using VR641 (25"/28").

Button No. Operation

1	Increase Red
2	Decrease Red
4	Increase Green
5	Decrease Green
7	Increase Blue
8	Decrease Blue

DRIVE ADJUSTMENT

- Receive the white raster signal.
- Select item "03 GRY".
- Adjust [R-Drive] and [B-Drive] control to obtain proper white balance by using **▶** + or **◀** - button.
 - Select [R-Drive] or [B-Drive] by using the **P▲** or **P▼** button.
 - Adjust [R-Drive] or [B-Drive] by using the **▶** + or **◀** - button.

RF-AGC ADJUSTMENT

- Input and tune an RF signal which is UHF ch31 551.25MHz with 63dBuV/75Ω terminated signal gain.
- Connect digital voltmeter to test point TP-A and GND.
- Enter the service mode and select mode "Regular", and select item "01 AGC".
- Press the **▶** + or **◀** - button to adjust voltage to be 3.2Vdc.

FOCUS ADJUSTMENT

By using FOCUS VR, adjust focus control for well defined scanning lines.

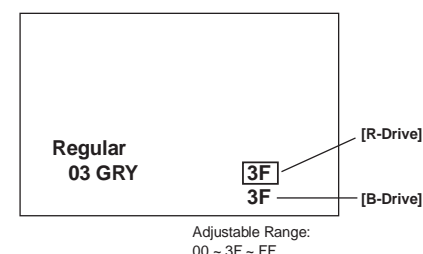

GREY SCALE ADJUSTMENT

CUT-OFF ADJUSTMENT

- Select AV mode with no signal input.
- Enter the service mode and select mode "Regular", item "02". The horizontal line will appear on the screen.
- Adjust the Screen VR on the FBT to obtain the one colour to be just visible.
- By using the buttons 1, 2, 4, 5, 7, 8 on the remote control, adjust the line to be white.

The key allocation is as follows;

HORIZONTAL PHASE ADJUSTMENT

- Receive circular pattern.
- Enter the service mode and select mode "Image", item "02 P H-P".
- Press the **▶** + or **◀** - button to adjust horizontal centre.



SERVICE ADJUSTMENTS

CPU PORT FUNCTIONS



HIGH-VOLTAGE CONFIRMATION

1. Receive circular pattern.
2. Connect a digital volt-meter to both terminals of 453, and a high voltage meter to CRT anode.
3. Confirm high voltage to be $25.0KV \pm 1 KV$ at beam current reading 1.1mV (21").
Confirm high voltage to be $26.0KV \pm 1 KV$ at beam current reading 1.2mV (25"), or 13mV (28").

VERTICAL PHASE ADJUSTMENT



1. Receive circular pattern..
2. Enter the service mode and select mode "Image, item "01 P V-P".
3. Press the  + or  - button to adjust vertical centre.

VERTICAL SIZE ADJUSTMENT

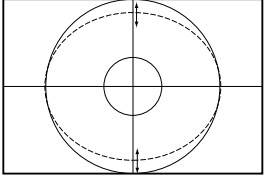
1. Receive circular pattern .
2. Enter the service mode and select mode "Image", item "05 P V-S".
3. Press the  + or  - button to adjust the vertical height.



OSD POSITIONING ADJUSTMENT

1. Receive circular pattern.
2. Enter the service mode and select mode "Regular", and select item "06 OSD". The OSD test bar will appear on the top of screen.
3. Press the  + or  - button to adjust proper OSD positioning.

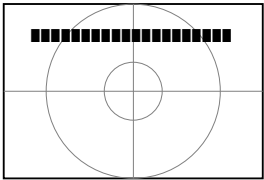

Pin No.	Function Name	Function	IN/OUT
1	RC IN	RC Signal Input	IN
2	RESET	Reset Input	IN
3	AUD-MUTE	TV Audio Mute Output "L": Mute On	OUT
4	P0.6	Note used	--
5	P0.5	Note used	--
6	P0.4	Note used	--
7	P0.3	Note used	--
8	KEY IN	Key Switch Signal Input	IN
9	P0.1	Note used	--
10	P0.0	Note used	--
11	PROTECT	Power Failure Detect Input "L": Error	IN
12	P3.6	Note used	--
13	P0.6	Note used	--
14	WE	Write Enable	OUT
15	B-OUT	Blue Output	OUT
16	G-OUT	Green Output	OUT
17	R-OUT	Red Output	OUT
18	BF-OUT	Fast Blanking Output	OUT
19	SDA	SDA	IN/OUT
20	SCL	SCL	OUT
21	VDD	Power	IN
22	JDTO	Not used	--
23	N.C	Not used	--
24	Vpp	Not used	--
25	AVDD3	Analogue VDD of PLL	--
26	TEST0	Test	--
27	MCFM	Test	--
28	JTCK	Test	--
29	TXCF	Analogue pin for the Teletext slicerline PLL	--
30	CVBS0	Not used	--
31	AVDD2	Analogue Power Supply	IN
32	JTMS	Not used	--
33	CVBS2	Composite Video Signal Input	IN
34	CVBS1	Composite Video Signal Input	IN
35	AGND	Digital Ground	--
36	GND	Analogue Ground	--
37	JTRSTO	Test	--
38	PXFM	Analogue pin for the Display Pixel Frequency Multiplier	--
39	AVDD	Analogue Power Supply	IN
40	H-SYNC	Horizontal Sync. Input	IN
41	V-SYNC	Vertical Sync. Input	IN
42	ACK	Answer for STATUS	OUT
43	STATUS	Request for bus open	IN
44	IGNOA	RGB on/off Switch	OUT
45	AMP-MUTE	Mute on/off SWitch	OUT
46	P4.4	Not used	--
47	LED2	LED Drive	OUT
48	P4.6	S-Video	--
49	P4.7	Not used	--
50	OSCOU	Oscillator Output	OUT
51	OSCIN	Oscillator Input	IN
52	RF AGC	RF Gain Control	IN
53	P2.4	Not used	--
54	POWER	Power on/off Switch	OUT
55	IF AGC	IF Auto gain Control	IN
56	8PIN	AV Input Detect	IN

CRT BOARD

